



SUB-MICRON UNIVERSAL TABLET MICROMETER

USER MANUAL





Item No	Range		Resol.	Accur.	NON-ROTATING	Analog scale	Graphical mode	Preset	Go/NoGo	Max/Min	Formula	Timer	Temp corr	Linear corr	Calibr date	Connect. status	Recharge batt	2D Synchronize	Memory	Wireless	USB	Color Display
	mm	inch																				
110750258	0-25	0-1"		±3	•	•	•	•	•	•	•	•	•	•	•	•	•	•				
110750508	25-50	1-2"		±3	•	•	•	•	•	•	•	•	•	•	•	•	•	•				
110750758	50-75	2-3"		±4	•	•	•	•	•	•	•	•	•	•	•	•	•	•				
110751008	75-100	3-4"		±4	•	•	•	•	•	•	•	•	•	•	•	•	•	•				
110751258	100-125	4-5"		±5	•	•	•	•	•	•	•	•	•	•	•	•	•	•				
110751508	125-150	5-6"		±5	•	•	•	•	•	•	•	•	•	•	•	•	•	•				
110751758	150-175	6-7"		±6	•	•	•	•	•	•	•	•	•	•	•	•	•	•				
110752008	175-200	7-8"		±7	•	•	•	•	•	•	•	•	•	•	•	•	•	•				
110752258	200-225	8-9"	0,0001	±7	•	•	•	•	•	•	•	•	•	•	•	•	•	•				
110752508	225-250	9-10"	0.001	±8	•	•	•	•	•	•	•	•	•	•	•	•	•	•				
110752758	250-275	10-11"	0.01	±8	•	•	•	•	•	•	•	•	•	•	•	•	•	•				
110753008	275-300	11-12"		±8	•	•	•	•	•	•	•	•	•	•	•	•	•	•				
110754008	300-400	12-16"		±10	•	•	•	•	•	•	•	•	•	•	•	•	•	•				
110755008	400-500	16-20"		±10	•	•	•	•	•	•	•	•	•	•	•	•	•	•				
110756008	500-600	20-24"		±12	•	•	•	•	•	•	•	•	•	•	•	•	•	•				
110757008	600-700	24-28"		±14	•	•	•	•	•	•	•	•	•	•	•	•	•	•				
110758008	700-800	28-32"		±14	•	•	•	•	•	•	•	•	•	•	•	•	•	•				
110759008	800-900	32-36"		±15	•	•	•	•	•	•	•	•	•	•	•	•	•	•				
110750008	900-1000	36-40"		±15	•	•	•	•	•	•	•	•	•	•	•	•	•	•				

Folders / 2000 val
 Long range / HID
 USB HID / Update
 Touchscreen 2.4"

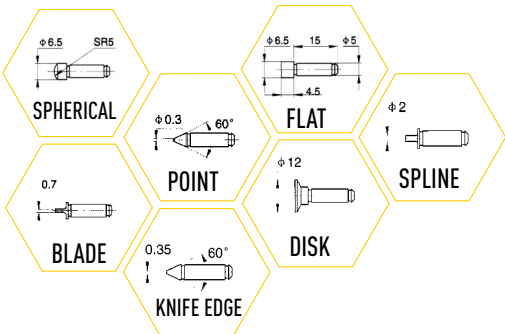

7 PAIRS OF ANVILS

MAIN INFO

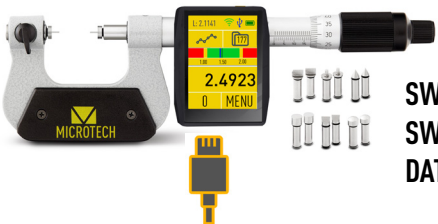

- SWITCH ON DEVICE - button push (1 sec)
- SWITCH OFF DEVICE - button push (3 sec)/ auto switch off
- DATA TRANSFER - programming throw menu

BUILT-IN BATTERY - rechargeable Li-Pol battery

DATA TRANSFER



MICROTECH

3 MODES OF DATA TRANSFER (USB + 2 WIRELESS MODES)

WIRELESS CONNECTION TO MDS APP

WIRELESS data transfer to MICROTECH
MDS app for Windows, Android, iOS



FREE SOFTWARE



NO DONGLE



SAVING DATA TO XLS, CSV FORMATS

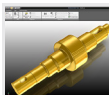

TRANSFER DATA TO CAD, SPC OR OTHER SOFTWARE



TRANSFER DATA TO EXCEL OR OTHER TABLE EDITORS



SAVING GRAPH

WIRELESS HID CONNECTION USB HID CONNECTION



NO DONGLE

WIRELESS HID and USB HID data transfer (like keyboard) direct to any customers app and system



TRANSFER DATA TO CAD, SPC OR OTHER SOFTWARE



TRANSFER DATA TO EXCEL OR OTHER TABLE EDITORS



TRANSFER DATA TO ANY BROWSER OR APP

7 WAYS HOW TO TRANSFER DATA TO PC OR TABLET

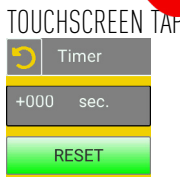

BY TIMER

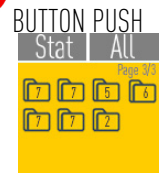
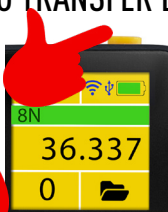

FROM MEMORY

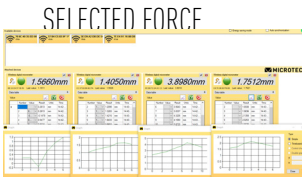

IN MDS APP





MAIN SCREEN

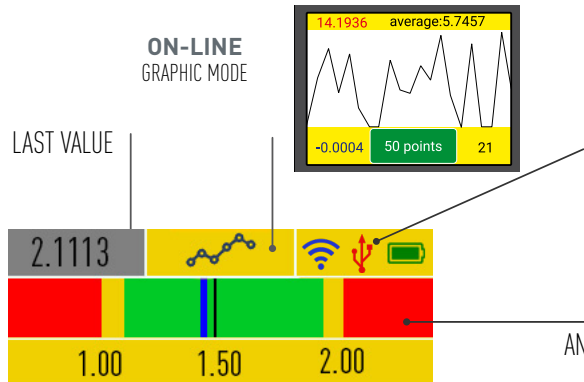

CONNECTION STATUS

- WIRELESS DISCONNECTED
- WIRELESS CONNECTED
- WIRELESS HID CONNECTED
- USB HID DISCONNECTED
- USB HID CONNECTED

0 1.4705 MENU 177

MEMORY



STANDARD or FOLDER system can be activated throw MEMORY menu

For save measuring data to internal device memory touch data area on screen or button push. You can view saved data or send by WIRELESS or USB connection to Windows PC, Android or iOS It's possible to use Standard or Folders memory modes

FOLDERS SYSTEM

Stat	All
7	7
5	6
7	2

MEMORY 2000 VAL.

Stat	All
1:	0.0000
2:	1.2334
3:	1.2337
4:	1.2333
5:	1.2341

Stat All Delete or Send?

Del Send

Statistic

MAX:	+26.999
MIN:	8.8673
AVG:	+5.3213
D:	+26.863

MAIN SCREEN on 2D mode

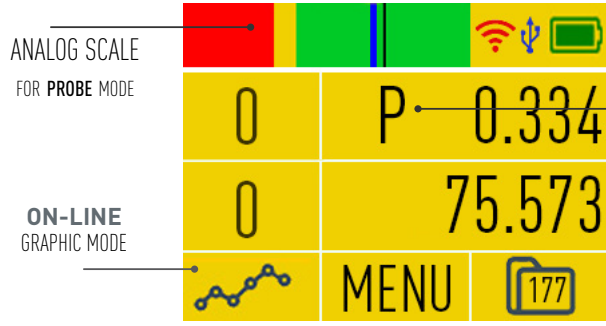

2D AND HUB MODE

- PROBE** - Saving data when Probe will reach value
- PROBE Auto** - Saving data when Probe will reach value with this value compensation
- 2D** - 2 axis data reading
- 2D Sync** - Synchronized 2 axis data reading

FUNCTIONS



MICROTECH

LIMITS mode GO/NOGO



MAX - NoGo more Upper limit
MIN - NoGo less Lower limit
RANGE - Go between Limits
NONE - Analog scale active

COLOR INDICATION LIMITS ON MAIN SCREEN Go NoGo

Y	2.000	Upper limit
Λ	3.000	Lower limit
%	20	Yellow zone on analog scale
	SCALE	RES

PEAK mode MAX/MIN



DISABLE - non active mode
ENABLE - activating mode
REFRESH - refresh peak value according timer

INDICATION AND SAVING MAX OR MIN VALUES

Max/Min	
Enabled	MAX - indicating MAX measured value MIN - indicating MIN measured value
MAX	

TIMER mode



SAVING DATA TO MEMORY OR SENDING WIRELESS/USB BY TIMER

Timer	
0.000 sec	Select timer period
Reset	Reset to deactivate mode

FORMULA mode



Formula	
Ax ² +Bx+C	Select FORMULA Type (Math, Radius or other)
Set Argv	Select arguments

RESOLUTION selection



Resolution	
X.0000	Resolution selecting
mm	mm/inch conversion

DISPLAY settings



Sleep OFF (15 s low brightness off, sleep off)
 Sleep 15s (15 s low brightness on, sleep off)
 Sleep ON (15 s low brightness on, sleep on)

Display	Display rotation 0°, 90°, 180°, 270°
Angle 270	
Sleep ON	Brightness level

LINEAR error compensation



Re-calculation detail size to calibration conditions (20°C)

Linear correction error's on device

O: 17.251	actual values
C: 17.258	correct values by up&down button
UP	confirm point correction
DN	RES

TEMP compensation



Manual Temperature setting

Temp.com.	
Cu, Cu alloys	
27.5°C	RES

4 types of material for selection:

- Glass, Quartz
- Stainless steel
- Cuprum and alloys
- Aluminium and alloys



WIRELESS data transfer



Reconnection button
Wireless power regulation



ON - WIRELESS data transfer to MDS App for Android, iOS, Windows
HID- WIRELESS HID direct transfer data to any App in Windows, MacOS, Linux, Android devices (like keyboard). Configure data format in USB sub-menu
2D-S - Slave device on WIRELESS connection on HUB mode
2D-M - Master device on WIRELESS connection on HUB mode

USB OTG data transfer

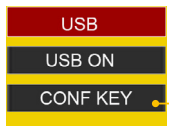

Connect USB cable to PC & Activate USB HID connection mode
Select setting of data transfer
Direct transfer data to any App in Windows, MacOS, Linux, Android devices
Configuring data transfer Dot/Comma and Tab/Arrow Down/CR+LF

HUB connection



A.C.on - Auto Connection active
A.C.off - Auto Connection no active
PROBE -Saving data when Probe will reach value
PROBE Auto - Saving data when Probe will reach value with this value compensation
2D - 2 axis data reading
2D Sync- Synchronized 2 axis data reading
Disable - switch off modes

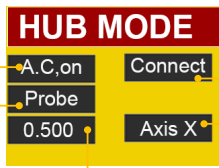

PROBE MODE
External Wireless device connection
Axis priority selecting
Setting PROBE limit value

A.C.on - Auto Connection active
A.C.off - Auto Connection no active
PROBE -Saving data when Probe will reach value
PROBE Auto - Saving data when Probe will reach value with this value compensation
2D - 2 axis data reading
2D Sync- Synchronized 2 axis data reading
Disable - switch off modes

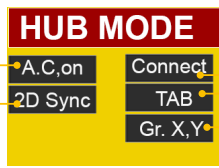

2D MODE
External Wireless device connection
Symbol between Axis
Graphic mode indication setting

FUNCTIONS



MICROTECH

LINK to app's



QR Link to MICROTECH web site page with MDS Software download

- Android, iOS, Windows versions
- Free and Pro versions
- Manuals

RESET to Factory settings

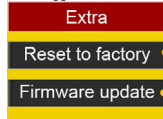

Push 10 times to RESET device to factory settings

Push 10 times to FIRMWARE UPDATE

EXTRA

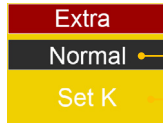

Selecting normal or inverted axis mode (+/- value indication)

Coefficient setting (for distributor and calibration only)

MEMORY manager setting

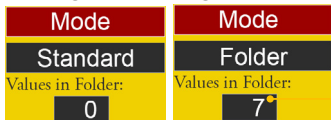

Activating STANDARD or FOLDER SYSTEM

Values in each Folder

FOLDERS SYSTEM

CALIBRATION date info

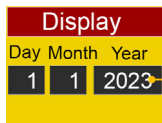

Push for change calibration date info

Device INFO



Information about device

- Firmware version
- MAC adress for WIRELESS connection



MICROTECH

INDUSTRY 4.0 INSTRUMENTS

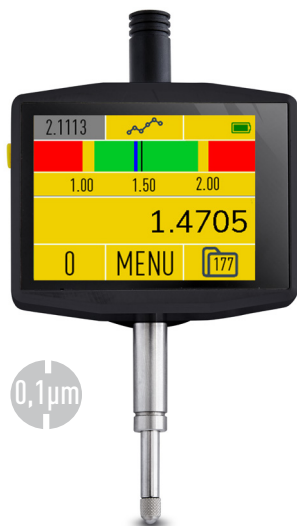

0,1µm

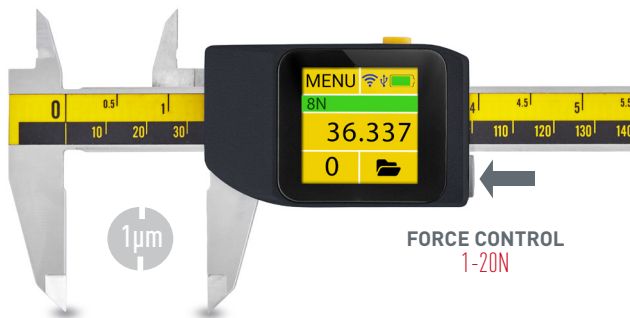

FORCE CONTROL
1-20N



0,1µm



0,1µm



1µm

MICROTECH

innovative measuring instruments

61001, Kharkiv, Ukraine, str. Rustaveli, 39

tel.: +38 (057) 739-03-50

www.microtech.ua

tool@microtech.ua

Change without prior notice