

BEARING CONTROL STAND KIA, SIA, KEA USER MANUAL





Item No	Range		Reso- lution	Repea- tability	Weights		Preset
	internal SIA KIA	external KEA			internal SIA KIA	external KEA	
	mm	mm			mm	mm	
255500001	20-200	10-140	0,001	0,005	10-40N 22pcs	12-40N 23pcs	•

PROCESS



Use fixators on jaws for different positions and Beraing diameters

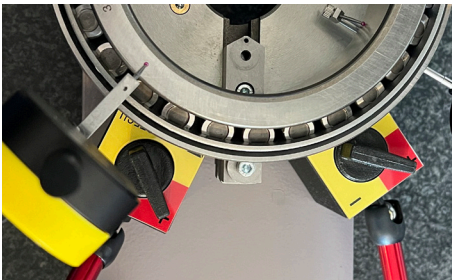

Install magnetic bases on chuck



Use weights from SET during a measurings

INSTALLATION



MICROTECH

SIA

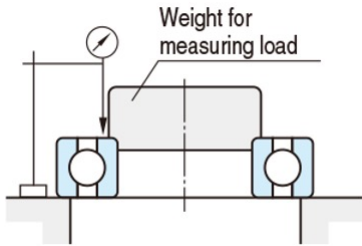

KIA

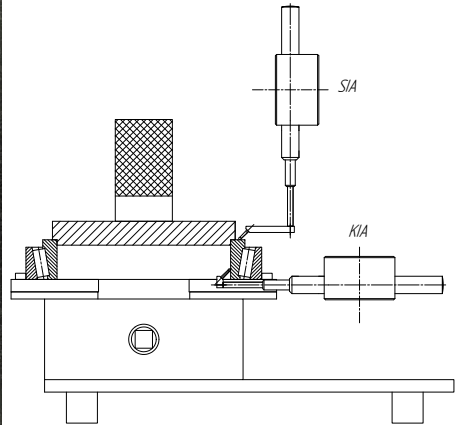
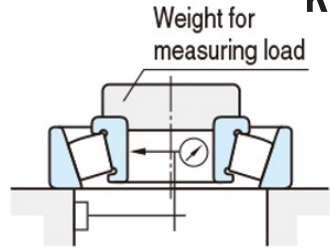

KEA

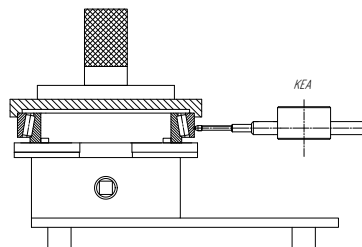
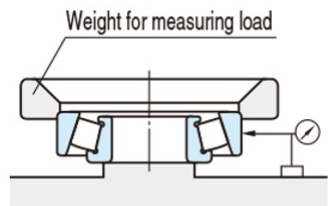



MICROTECH

INDUSTRY 4.0 INSTRUMENTS

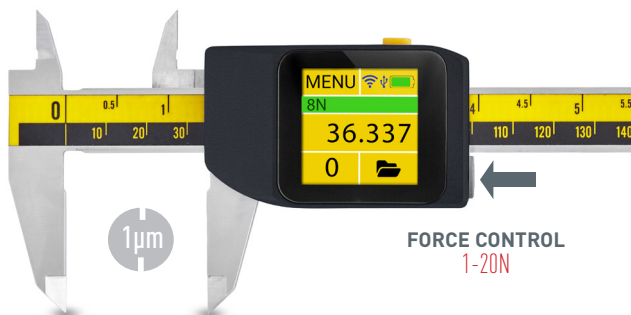
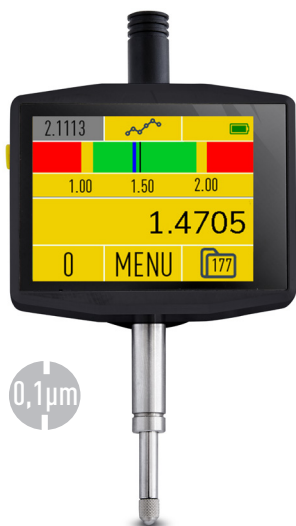

MICROTECH

innovative measuring instruments

61001, Kharkiv, Ukraine, str. Rustaveli, 39

tel.: +38 (057) 739-03-50

www.microtech.ua

tool@microtech.ua

Change without prior notice